

SKYVIEW SHADES™ BY WILCO PRODUCTS

SOLARIUM AND SUNROOM SHADES

Four Seasons Models

INSTALLATION INSTRUCTIONS

(Please read all instructions prior to installation)

1. Unwrap the shade. Be careful not to misplace the bag with screws and clips.

General: These shades travel in the tracks located on the sides of the bay beams. It will be necessary to have access to this track – probably at the top of the roof. If you have both a front vertical shade and a flat roof shade, they both are fed into this track from the top. If there is no opening to the track you will have to create one by drilling into the track a 5/16" wide area, 3/4" long at the top of the track slot- 1/2" – 1" from the end. You can cut this opening with a Dremmel disc bit or a Roto Zip tool. A regular drill tends to wander and does not produce a clean opening. The aluminum slats located in **every 4th cell** of the fabric are also feed into this track. See last page for SHADE LAYOUT.

Check at this time to see if the opening to the track throughout its length maintains its width of about 5/32 (.150"). The tips on the slats have a width of slightly more than 1/8" of .130". If the area around the curve is compressed you may have to widen this area by using a Roto Zip tool, file or drill to expand the opening

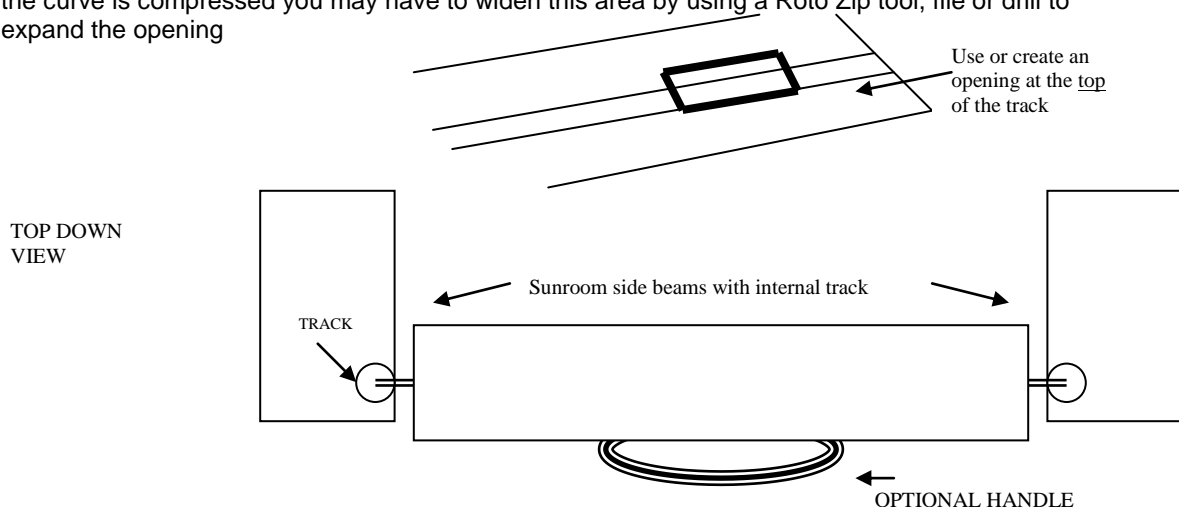

NOTE: If there are two shades in one bay there will be a nylon stop slid down the track after the front vertical shade is slid into the track and fixed in place at the cross beam just as the curve starts. Be sure to remember this before feeding the roof shade down the track.

For All Shades: Insert the aluminum slats into **every 4th cell** with the concave side facing the same direction in each cell and in each shade.

Front Vertical Shade. (If you only have one shade for the bay go to step 1 under Top Roof Shade)

1. This shade will have the headrail snapped into brackets positioned at the bottom of the front vertical bay. Position two brackets approximately 3" from each side of the beam and centered with the tracks. Attach with one screw each.

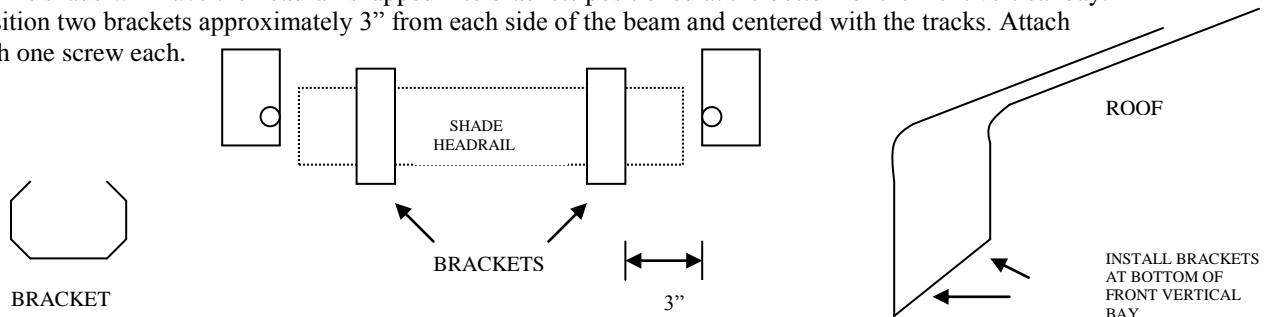

2. While holding the shade and shade fabric in one hand slide the plastic tubes at the ends of the headrail (the rail to which the fabric is attached with no handle or recess for a telescopic pole) down the track from the top of the sunroom. First push the tube at one end of the headrail in the track and then push the other tube in the opposite track. Make sure the colored side of the fabric is facing inside of the room – white to the outside and the handle or recess in the travel rail is facing the inside of the room also. The plastic tubes at the end of the headrail fit into the track while the plastic end caps of the shade headrail stay outside. These parts are spring tensioned to allow the shade to stop at any position desired. **You may want to use the end of a pointed object (nail etc) to push the plastic tube away from the shade end cap and into the track.**

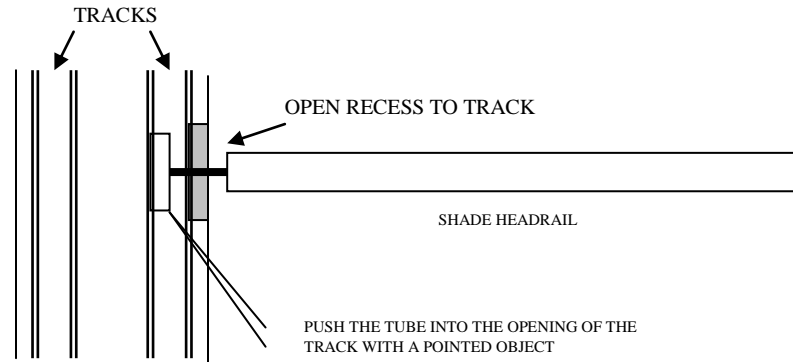

3. Feed the aluminum slats with plastic rods into the track. Pull the shade gradually down the beam until all of the slats are in the track and then pull the shade down to the front position where the clips have been located. Snap the headrail into these brackets.

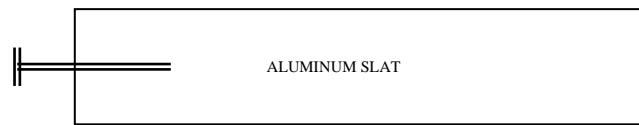

4. From the top of the track feed down the plastic stop assembly – the plastic nut being located inside the track and the washer and bolt head located outside. Once the stop assembly is opposite the cross bar where the curved glass ends tighten the bolt to fix the stop assembly at that position. Do the same to the opposite track.

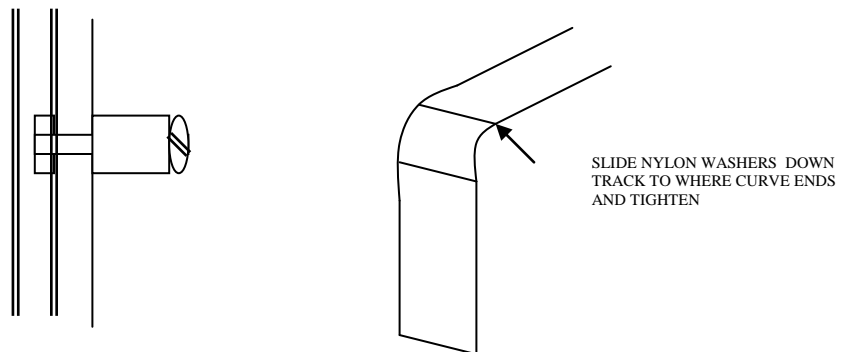

5. Pull the front shade travel rail up to the stops. It should stop at any position on the way up to these stops.

Top Roof Shade:

1. The brackets to hold the headrail to the top of the window may be attached either directly to the top of the window bay (A) or to the sides by using the included “L” brackets (B). It depends upon how much room there is between the opening in the beam to the track and the back wall.

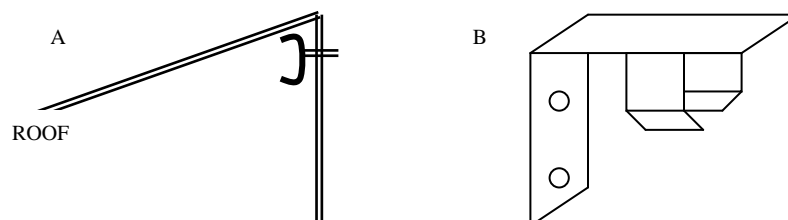

You may want to install these before inserting the roof shade in the track or afterwards. It depends if there will be enough room to slide the shade in the track if the brackets are already installed. They will be located so that the center of the clips are lined up with the center line of the track – the same as in step one under Vertical Front Shade.

2. Feed the roof shade down the track in the same manner as the front vertical shade – this time with the travel rail first – ie the rail with the recess in the center or a handle attached. Again, be sure the color of the fabric is facing inside the room and the white side is facing outside. Then feed the aluminum slats into the track. Once these are all in the track install the end brackets (if not previously done so) and snap the headrail into the brackets.
3. Pull the shade along the track with the handle or telescopic pole to meet the stops previously placed in the track where the curve begins.
4. At the top of the roof where you fed the shade into the track place a bolt or screw to prevent the shade slats and rails from coming out when the shade is retracted.

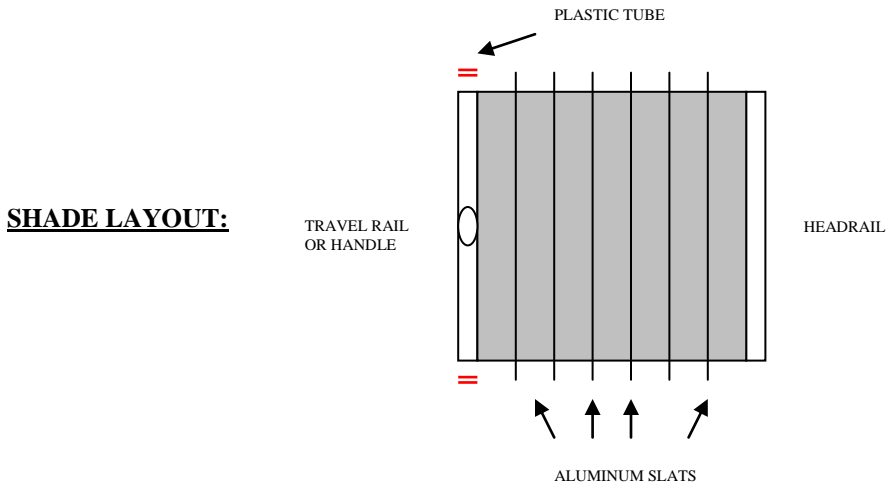

If you encounter any problems in this assembly please call us during regular business hours.

36 Months RESIDENTIAL ONE YEAR COMMERCIAL LIMITED WARRANTY

WILCO WARRANTS THAT ALL SKYVIEW SHADES WILL BE FREE FROM DEFECTS IN MATERIALS AND WORKMANSHIP FOR A PERIOD OF 36 MONTHS FROM THE DATE OF PURCHASE FROM WILCO OR ONE OF ITS LICENSED DISTRIBUTORS OR INSTALLERS: PROVIDED THAT SUCH PRODUCTS WERE PROPERLY INSTALLED AND THAT THEY WERE HANDLED IN A CAREFUL MANNER.

THE OBLIGATION OF WILCO AND ITS LICENSED DISTRIBUTORS AND INSTALLERS IS LIMITED TO THE REPAIR OR REPLACEMENT OF THE SHADES FOUND TO BE DEFECTIVE AND EXCLUDES SHIPPING CHARGES AND LABOR COSTS FOR MEASURING AND INSTALLATION. REPAIRS WILL BE MADE WITH LIKE OR SIMILAR PARTS.

TO OBTAIN WARRANTY SERVICE, CONTACT THE DISTRIBUTOR OR INSTALLER FROM WHOM YOU PURCHASED THE SKYVIEW SHADE. THE DISTRIBUTOR OR INSTALLER WILL WORK DIRECTLY WITH WILCO TO PROMPTLY REPAIR OR REPLACE ANY DEFECTIVE PART WITHOUT CHARGE. IF YOU REQUIRE FURTHER ASSISTANCE, CONTACT WILCO AT THE ADDRESS OR TELEPHONE NUMBER LISTED BELOW. WARRANTY CLAIMS MUST BE ACCOMPANIED BY PROOF OF PURCHASE, AS WELL AS DETAILS REGARDING THE NATURE OF THE PROBLEM, LOCATION OF THE SHADE ETC..

THIS WARRANTY DOES NOT INCLUDE ANY CONDITIONS OR DAMAGES RESULTING FROM ACCIDENTS, ALTERATIONS, MISUSE, ABUSE, NON-RECOMMENDED MOTORIZED DEVICES, OR FAILURE TO FOLLOW OUR INSTRUCTIONS WITH RESPECT TO MEASUREMENT, INSTALLATION, CLEANING OR MAINTENANCE. THIS WARRANTY ALSO DOES NOT COVER ANY CONDITION OR DAMAGE RESULTING FROM REMOVAL OF THE SHADE AND REINSTALLATION IN THE SAME OR ANOTHER WINDOW. THIS WARRANTY ALSO DOES NOT APPLY TO CONDITIONS CAUSED BY NORMAL WEAR AND TEAR UPON THE PRODUCT.

THIS WARRANTY IS EXCLUSIVE AND IN LIEU OF ALL OTHER OBLIGATIONS, LIABILITIES OR WARRANTIES. IN NO EVENT SHALL WILCO OR ITS LICENSED DISTRIBUTORS OR INSTALLERS BE LIABLE OR RESPONSIBLE FOR INCIDENTAL OR CONSEQUENTIAL DAMAGES OR FOR ANY OTHER DIRECT OR INDIRECT DAMAGE, LOSS, COST, EXPENSE OR FEE.

**WILCO PRODUCTS LLC, 110 COPPERWOOD WAY, UNIT H, OCEANSIDE, CA 92054
TEL:760-721-1958 TOLL FREE: 888- 506-1900 FAX-760-721-3185**